



Agrotextiles

Lumilys[®]

Smart reflective groundcover

Installation instructions Quick Install

The product warranty will not be applicable if the product is not installed and used in strict accordance with these installation instructions.

For the use of Lumilys groundcover, the distance between the rows of trees is limited to maximum 14.11 ft (4.3m), or 11.81 ft (3.6m).

Lumilys is suitable for normal weather conditions.

The user must wear safety gloves and protective eyewear during installation.



Estimated installation time for
328 ft (100 m) Lumilys:
year x (step 1-6) : 40 minutes
year x+1 (step 2-6): 25 minutes



More info and videos on
www.lumilys.com

Storage

We advise to store the material between -20°C and 50°C. After usage store the enroled Lumilys as clean and dry as possible in order to maintain the functionalities and properties of the cover. By preference rolls are stored in vertical position.

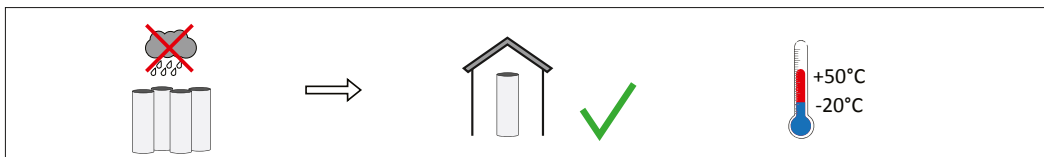

Tools

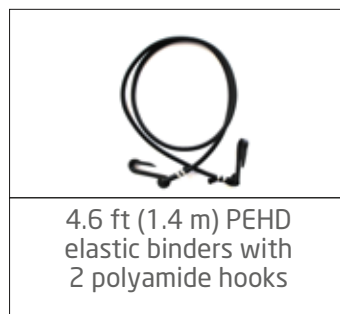
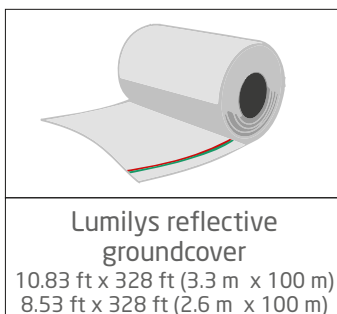

Use 270 elastic binders with hooks for one acre Lumilys 10.83 ft width, or 320 binders for 8.53 ft size.

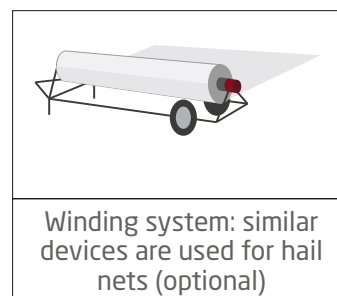
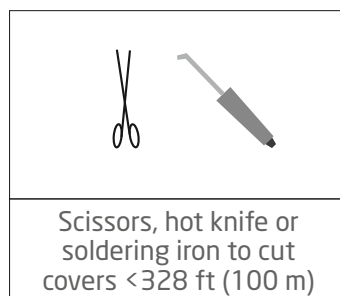

Lumilys[®]

Lumilys Quick Install

1. TIPS AND TRICKS

Mow grass before installation.

Install the cover 4-6 weeks before harvest at height of 4 in (10 cm) above the ground.

For easy installation year after year the elastics remain in place when the cover is not in use.

Use the clove hitch knot to fix the elastics to the trees.

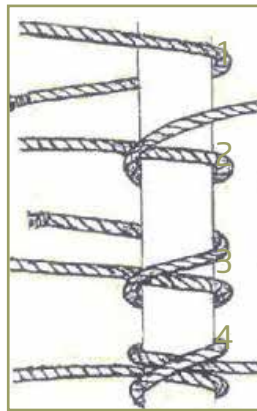

2. FIXATION

Step 1: Distribute and fix all elastics

Distribute an elastic every 13 ft (4 m). Only one elastic is needed for both sides of the tree. Install the elastics 4 in (10 cm) above the ground. Use a clove hitch knot and make sure both ends have the same length.

- Trees with elastics
- Trees without elastics

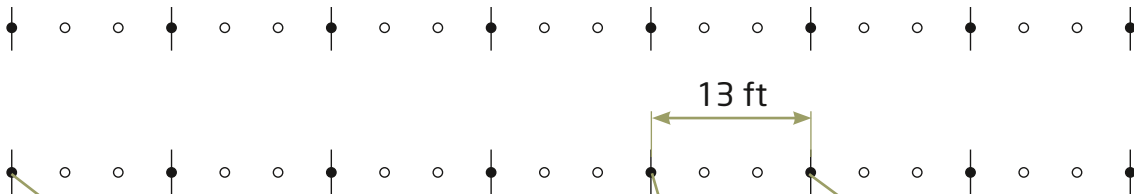

Lumilys[®]

Lumilys Quick Install

Step 2: Unroll and connect 50%

Start unrolling the cover, making sure it is centered properly. Punch the hooks through the groundcover at a 6 in (15 cm) distance from the side, perpendicular to the tree. There is no tension on the elastic. Repeat this action every 4m until 50% (=164 ft (50 m)) of the groundcover is reached.

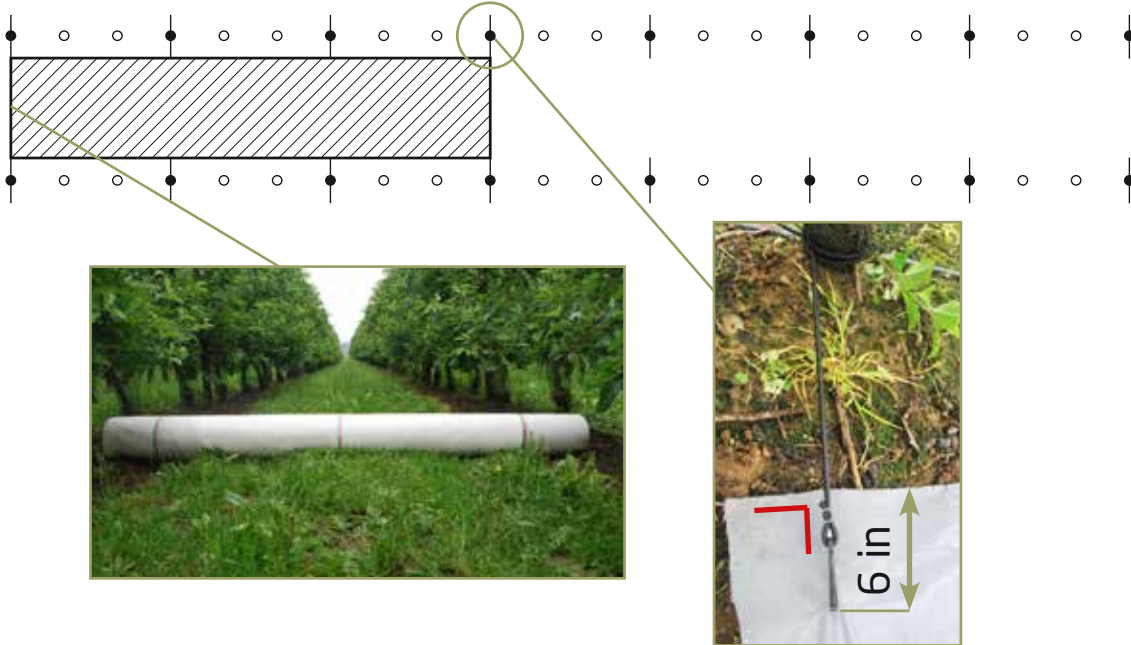

Step 3: Unroll and pull

Unroll the cover until the end without connecting hooks. Fix the end of the Lumilys cover to the tractor using two carabine hooks and a lashing strap (= tensioning tool). To achieve optimal tension of the fixed groundcover, use a tractor to pull the cover for 5 ft (1.5 m). The elastics will rotate in an angular position. Keep the tractor in current position as counterweight tool.

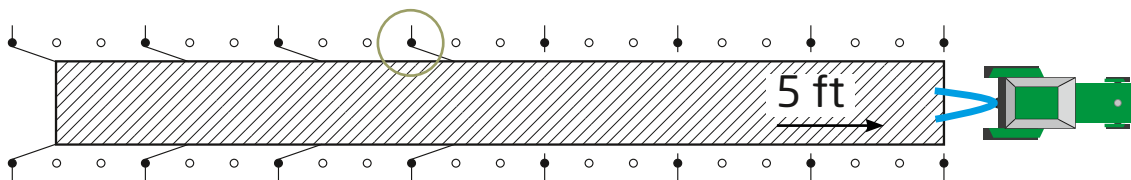

Step 4: Connect next 50%

While the cover is under tension, punch the remaining hooks perpendicularly in the cover (as in step 2).

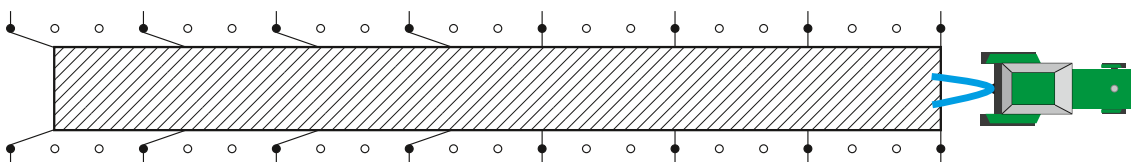

Lumilys Quick Install

Step 5: Release tension

Finally, detach the cover from the tractor. The tension will be divided equally over all elastics. The groundcover will automatically move to its final position.

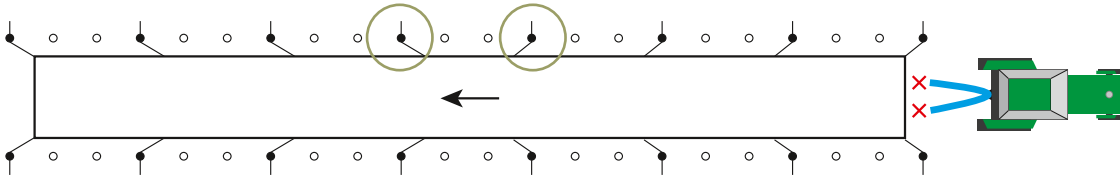

3. CUSTOMIZED LENGTHS

For rows longer or shorter than 328 ft (100 m), smaller sizes can be cut by a hot knife. Same installation method applies for these lengths.

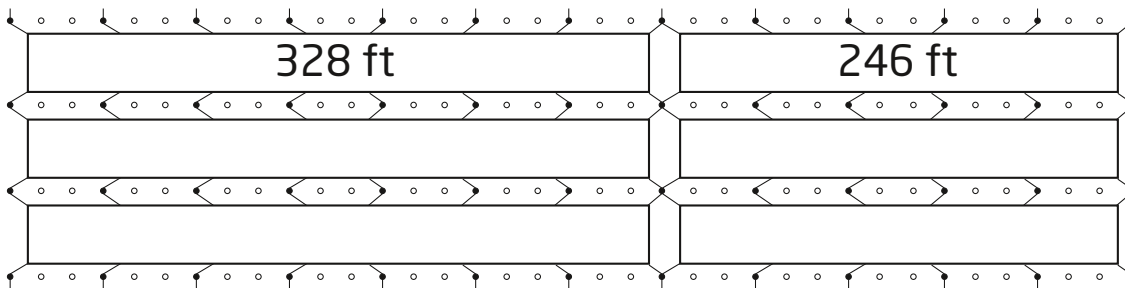

4. REMOVAL OF COVER BEFORE HARVEST

Remove the cover by loosening the hooks and winding it on the tube. A motorized winding system drastically cuts removal time and manpower and improves ergonomics. The elastics remain in place around the tree for next uses.

